

# Product Parts Breakdown

▲ Specify Finish

HS1070-9856 ▲  
Shower Arm w/o Flange

HS1070-9857 ▲  
Flange

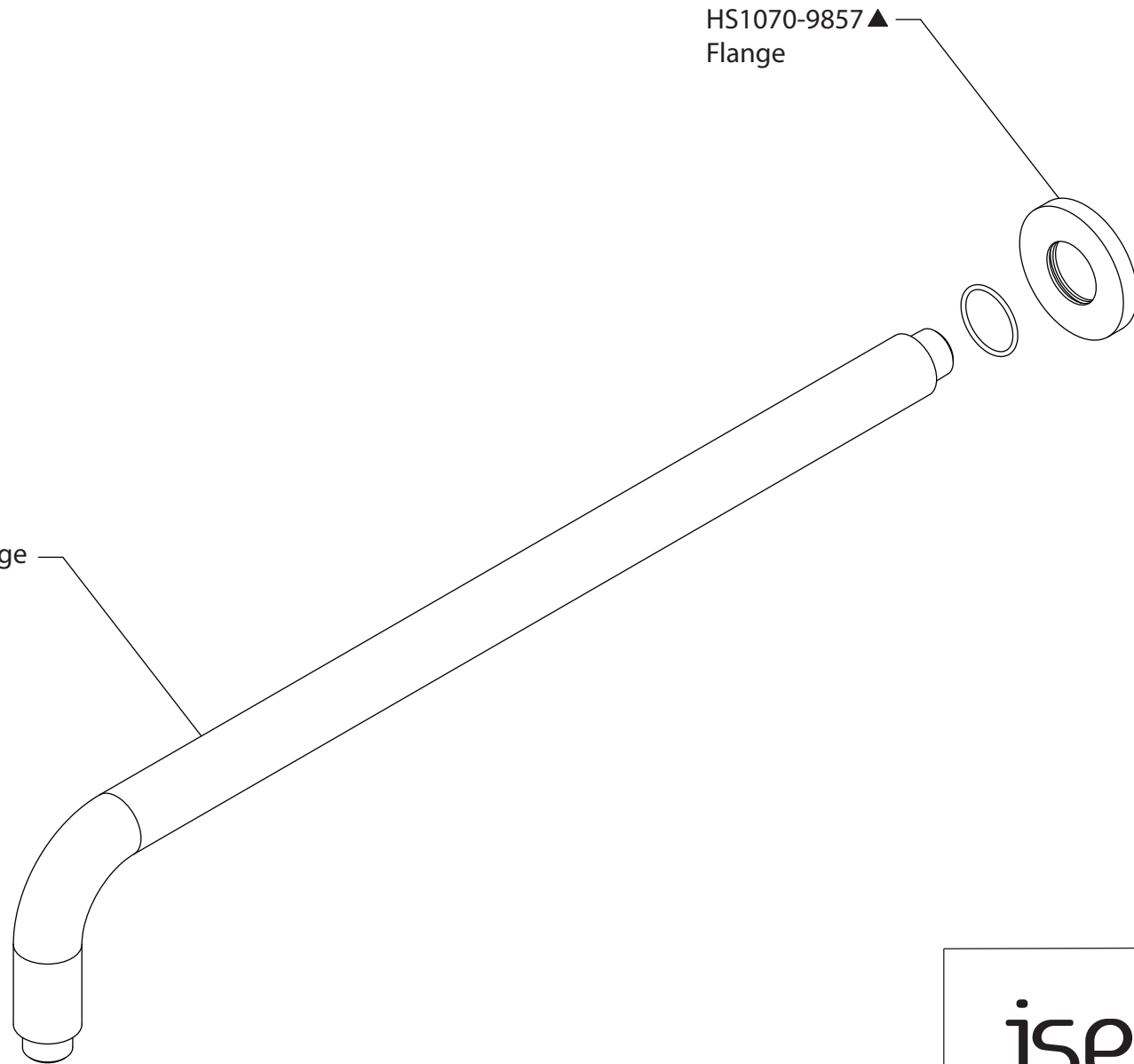

**isenberg**  
innovation+design

HS1070

Ver 2.53